



Attention
Risk of Danger,
Warning



High Voltage,
Risk of
Electric Shock



Double / Reinforced
Insulation



NOT
Litter



CE Mark

TECHNICAL SPECIFICATION



- **Dimensions** : 96x96mm
- **Panel Cut-out** : 91x91mm
- **Display** : 2x3 Digits 7 Segment
- **Sensor Type** : Fe-Const, J type T/C
- **Measuring Scale** : 0 .. 600 °C
- **SET interval** : 0 .. 450 °C
- **Hysteresis Interval** : Fixed; 3 °C
- **Resolution** : ± 1 °C



- **Accuracy** : ± 0.3 % (Over full scale)
- **Control Form** : ON-OFF
- **Out Output** : Relay (NO + NC), 250VAC, 2A, Resistive load
- **Cold. Junc. Comp.** : 0 .. 50 °C (T/C)
- **Sensor Failure** : Out is OFF in case of sensor failure, measurement out of range or hardware fails to measure input signal.



- **Supply Voltage** : 100..240VAC, 50-60Hz
- **Power Consumption** : < 6VA
- **Humidity** : 80% up to 30°C, then linearly decreases to 50% at 50°C (non-condensing)
- **Altitude** : < 2000 m



- **EMC** : EN 61000-6-1, EN 61000-6-3 (Only light industrial environment)
- **Safety** : EN 61010-1; Pollution degree 1, measurement category I, (Only light industrial environment, double/reinforced isolated, non-conductive pollution environment)





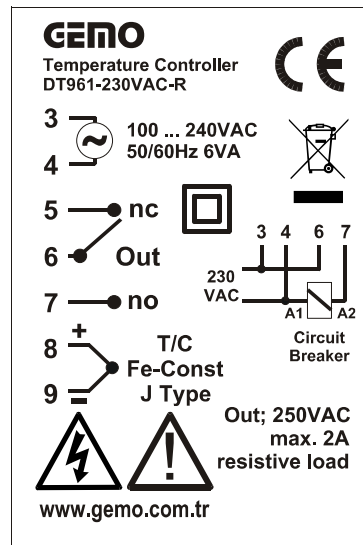



















- **Protection Class** : IP20; according to EN 60529
- **Operation Temp.** : 0 .. 50 °C
- **Storage Temperature** : -10°C .. 60°C (no icing)
- **Weight** : < 0.5 kg
- **Keys** : Micro switch
- **Torque for screwing** : Max. 0.5 N.m



no: normally open
nc: normally closed

INSTALLATION, USE and WARNINGS

-  This device and its packing is NOT litter and may NOT be disposed of with domestic waste. Please return this device and its packing to an appropriate recycling point at the end of its service life.
-  Please read this user manual carefully and completely before installation and use. Please take into consideration all warnings mentioned in this manual.
-  DT961 is suitable only for permanent panel type mounting
-  Installation and use of this device must be done by qualified, authorized and trained technical personnel only.
-  Inspect device carefully before installation. Do not install and use broken and defective devices.
-  Do not disassemble device. Do not make any repair on any part of the device. There is no accessible part inside the device. Please contact to manufacturer for broken and defective devices.
-  Do not use device in environments subject to flammable, explosive and corrosive gases and/or substances.
-  This device is designed for applications only in light industrial environments. This device is not suitable for medical and residential use. This device is not suitable for use related with human health and safety. This device is not suitable for automotive, military and marine use.
-  Do not allow children and unauthorized people to use this device.
-  Before installation and any technical work, disconnect the power supply and mains connections.
-  Check the power supply voltage level before power on, and make sure voltage level is in specified limits. Check quality of neutral line. Improper neutral line may give permanent damage to the device.
-  Connect an external power switch and an external fuse (1A, 250VAC) to the power supply line that are easily accessible for rapid intervention. Connect an external fuse (2A, 250VAC) for each relay output separately.
-  Use appropriate cables for power supply and mains connections. Apply safety regulations during installation.
-  Install the device in a well ventilated place. Install the device permanently into a proper panel cut-out. Fix the device with two fasteners supplied with the device. Only front panel must be accessible after installation is completed.
-  Do not operate the device other then the environmental conditions given in Technical Specification.
-  Do not operate the device in environments that may cause conductive pollution.
-  Take precautions against negative environmental conditions like humidity, vibration, pollution and high/low temperature during installation.
-  Use correct compensation cables for T/C sensors. Connect T/C cable directly to the device connectors.
-  Keep device, signal cables and communication cables away from circuit breakers, power cables and devices/cables emitting electrical noise. Use shielded and twisted signal and communication cables and connect shield to earth ground on device side. Keep length of signal and communication cables less than 3m.
-  In your applications, always use separate and independent mechanical and/or electromechanical devices/apparatus to support DT961 to handle emergency cases..
-  Use insulated cable end-sleeves at the end of cables screwed to the device connector terminals.
-  Maximum torque for screwing; 0.5 N.m.
-  Please check www.gemo.com.tr for latest device and documentation updates regularly. All updates and all information are subject to change without notice.

GENERAL SPECIFICATION

- This device is designed for basic temperature control applications only in light industrial environments.
- μ P based, digital temperature controller with single output
- Sensor:T/C, Fe-Const, J type
- ON-OFF control form
- Fix Hysteresis Value; 3°C
- Displays SET and PROCESS values
- Cold-junction compensation for T/C
- Excellent linearity with °C/mV look-up table
- High accuracy
- EEPROM memory to store settings
- Dimensions; 96x96mm
- Easy connection with plug-in connectors

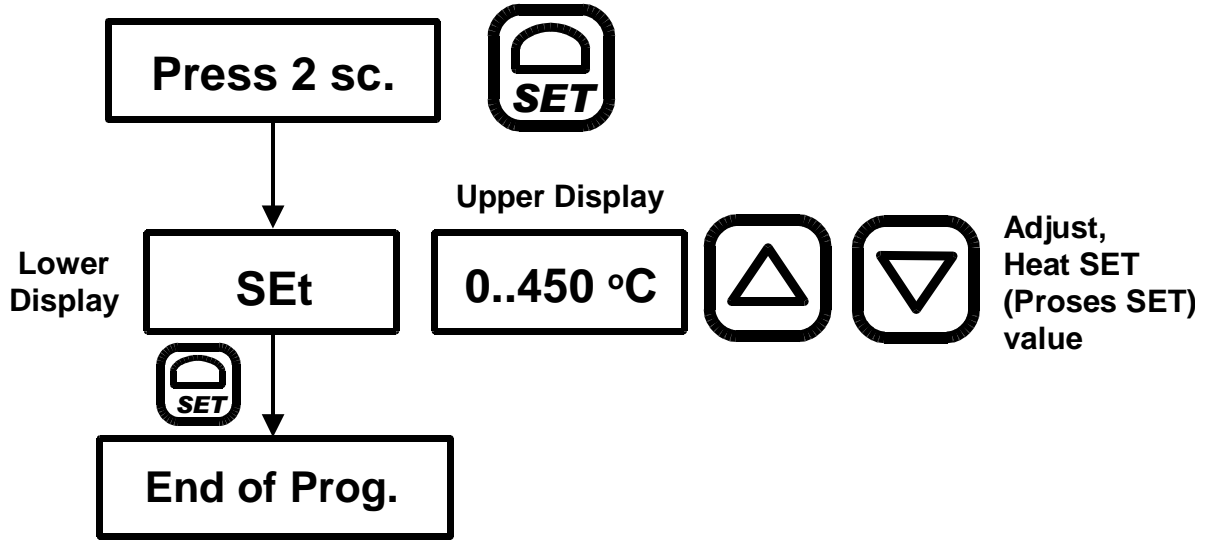
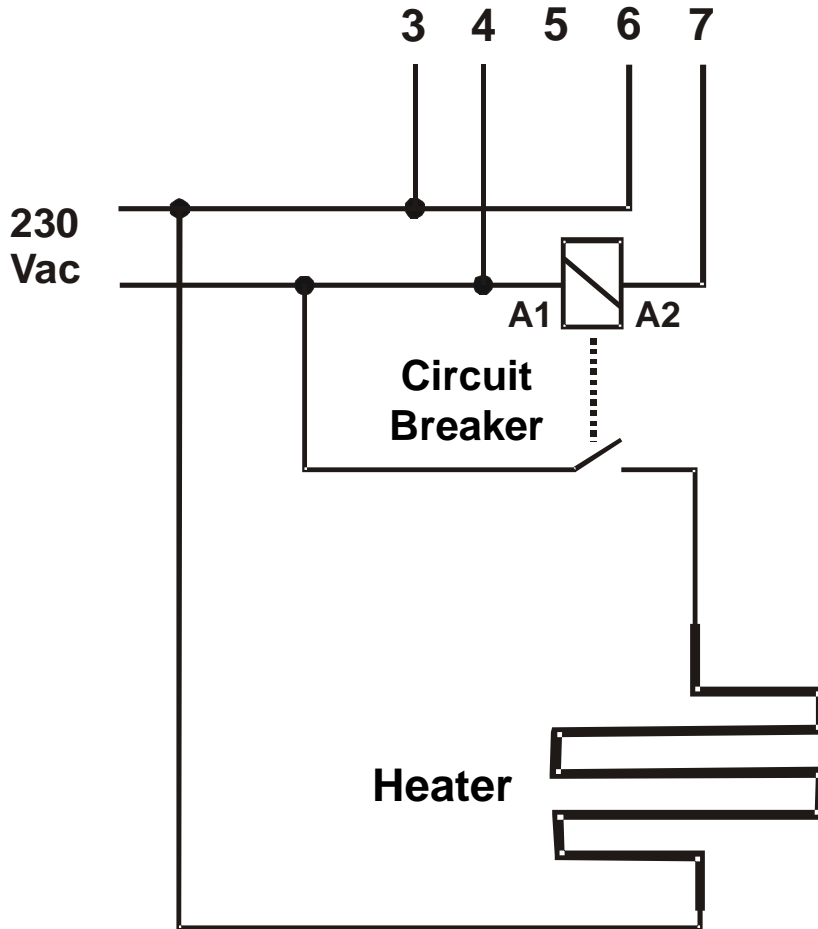
ADJUSTING SET VALUE**SAMPLE CONNECTION DIAGRAM**

ERROR MESSAGE

“**FAiL**”: Displays “FAiL” message in case of sensor failure, measurement out of range or hardware fails to measure input signal.

OUT CONTROL FORM; ON-OFF

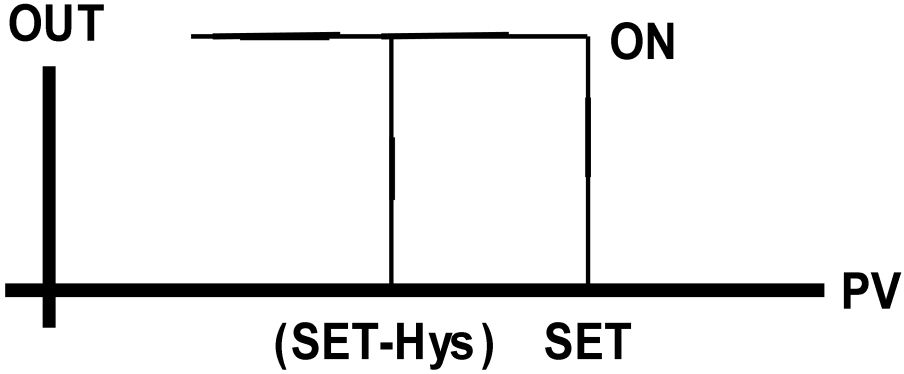

OUT relay is OFF when process value (PV) is greater then or equal to SET value. OUT relay is ON when PV is less then or equal to (SET-Hys) value (Hys has a fixed value of 3°C).

CLAEANING



Do not use any solvents (alcohol, thinners, benzine, acid, etc.) or corrosive substances to clean the device. Use only a dry and clean non-abrasive cloth. Before cleaning, disconnect the power supply and mains connections.